

Invoice to:
 Name:
 Street:
 Town: Postal code:
 E-Mail:
 Tel: Fax:
 Order date:
 Purchase order:

Deliver to:
 Name:
 Street:
 Town: Postal code:
 E-Mail:
 Tel: Fax:
 Marked for:

Fax number: +44 (0)845 605 66 89
 Email: orders@sunmed.co.uk

USER WEIGHT kg
 Crash tested and passed without tie down brackets

PLEASE CHOOSE ONE OF THE FOLLOWING FRAME OPTIONS

Helium Generation 2013
 Maximum user weight 125kg

Base price £2295

HUM030017
Helium Pro
 Maximum user weight 125kg
Fixed welded axle position
 (no rear seat height adjustment & +/- 1cm centre of gravity adjustment)
Standard angle adjustable back

£335

HUM030016
Helium Pro
 Maximum user weight 100kg
Fixed welded axle position
 (no rear seat height adjustment & +/- 1cm centre of gravity adjustment)
Fixed welded backrest set at*

-4° (86°)
 -2° (88°)
 0° (90°) £448
 +2° (92°) Figures in brackets are angle to ground
 +4° (94°)

*Must choose Oval Shaped Backrest

CLIENT MEASUREMENT

Seat width in cm (measured from outside frame tube to outside frame tube)

		32	34	36	38	40	42	44	46
Seat depth in cm	34	<input type="checkbox"/>	<input type="checkbox"/>	<input type="checkbox"/>	<input type="checkbox"/>	<input type="checkbox"/>	<input type="checkbox"/>	<input type="checkbox"/>	<input type="checkbox"/>
	36	<input type="checkbox"/>	<input type="checkbox"/>	<input type="checkbox"/>	<input type="checkbox"/>	<input type="checkbox"/>	<input type="checkbox"/>	<input type="checkbox"/>	<input type="checkbox"/>
	38	<input type="checkbox"/>	<input type="checkbox"/>	<input type="checkbox"/>	<input type="checkbox"/>	<input type="checkbox"/>	<input type="checkbox"/>	<input type="checkbox"/>	<input type="checkbox"/>
	40	<input type="checkbox"/>	<input type="checkbox"/>	<input type="checkbox"/>	<input type="checkbox"/>	<input type="checkbox"/>	<input type="checkbox"/>	<input type="checkbox"/>	<input type="checkbox"/>
	42	<input type="checkbox"/>	<input type="checkbox"/>	<input type="checkbox"/>	<input type="checkbox"/>	<input type="checkbox"/>	<input type="checkbox"/>	<input type="checkbox"/>	<input type="checkbox"/>
	44	<input type="checkbox"/>	<input type="checkbox"/>	<input type="checkbox"/>	<input type="checkbox"/>	<input type="checkbox"/>	<input type="checkbox"/>	<input type="checkbox"/>	<input type="checkbox"/>
	46	<input type="checkbox"/>	<input type="checkbox"/>	<input type="checkbox"/>	<input type="checkbox"/>	<input type="checkbox"/>	<input type="checkbox"/>	<input type="checkbox"/>	<input type="checkbox"/>
	48	<input type="checkbox"/>	<input type="checkbox"/>	<input type="checkbox"/>	<input type="checkbox"/>	<input type="checkbox"/>	<input type="checkbox"/>	<input type="checkbox"/>	<input type="checkbox"/>

- Please note the procedure of the measurement is from the back
 - All measurements are in cm and without a cushion

High frame is 4cm higher than low frame and you can choose shorter and lighter forks to minimise the weight of your wheelchair. See next page

		Front seat height in cm																	
		Fork (Length x Width)	Frame	43	44	45	46	47	48	49	50	51	52	53	54	55	56	57	
Front Castor	3"	111 mm	Low	<input type="checkbox"/>	<input type="checkbox"/>	<input type="checkbox"/>													
		111 mm	High					<input type="checkbox"/>	<input type="checkbox"/>	<input type="checkbox"/>									
	4"	111 mm (1)	Low		<input type="checkbox"/>	<input type="checkbox"/>	<input type="checkbox"/>	<input type="checkbox"/>											
		123 mm (2)			<input type="checkbox"/>	<input type="checkbox"/>	<input type="checkbox"/>	<input type="checkbox"/>											
		Frog Leg (2)						<input type="checkbox"/>	<input type="checkbox"/>	<input type="checkbox"/>									
		111 mm (1)	High						<input type="checkbox"/>	<input type="checkbox"/>	<input type="checkbox"/>	<input type="checkbox"/>							
		123 mm (2)								<input type="checkbox"/>	<input type="checkbox"/>	<input type="checkbox"/>	<input type="checkbox"/>						
		Frog Leg (2)										<input type="checkbox"/>	<input type="checkbox"/>	<input type="checkbox"/>					
	5"	111 mm (1)	Low				<input type="checkbox"/>	<input type="checkbox"/>	<input type="checkbox"/>										
		123 mm (2)						<input type="checkbox"/>	<input type="checkbox"/>	<input type="checkbox"/>									
		Frog Leg (2)	High							<input type="checkbox"/>	<input type="checkbox"/>	<input type="checkbox"/>	<input type="checkbox"/>					<input type="checkbox"/>	<input type="checkbox"/>
		111 mm (1)									<input type="checkbox"/>	<input type="checkbox"/>	<input type="checkbox"/>	<input type="checkbox"/>					
	6"	123 mm (2)	Low						<input type="checkbox"/>	<input type="checkbox"/>	<input type="checkbox"/>								
		Frog Leg (2)										<input type="checkbox"/>	<input type="checkbox"/>	<input type="checkbox"/>					
		123 mm (2)	High											<input type="checkbox"/>	<input type="checkbox"/>	<input type="checkbox"/>			
		Frog Leg (2)													<input type="checkbox"/>	<input type="checkbox"/>	<input type="checkbox"/>		<input type="checkbox"/>

Your rear seat height can only be between 0cm and 13cm below your front seat height:
 i.e. rear seat height CANNOT be above front seat height.
 i.e. rear seat height CANNOT be more than 13cm below front seat height.
 - More info, see page 2
 # 4" & 5" soft roll and 5" & 6" soft solid are only available with a 45 mm fork

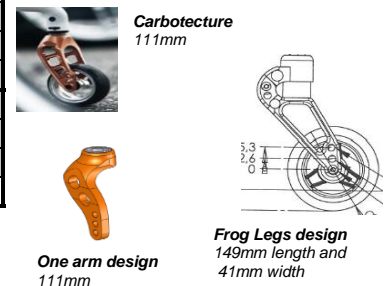

(1): Also available as one arm fork; please choose the fork type on page 4
 (2): Compatible with Power-Add on devices

REAR WHEELS															
Rear wheel	Rear seat height in cm (The ordered rear seat height is adjustable +/- 1cm on each chair. Excludes Helium Pro.)														
	Wheels	37*	38*	39	40	41	42	43	44	45	46	47	48	49*	50*
	24"	<input type="radio"/>	<input type="radio"/>	<input type="radio"/>	<input type="radio"/>	<input type="radio"/>	<input type="radio"/>	<input type="radio"/>	<input type="radio"/>	<input type="radio"/>	<input type="radio"/>	<input type="radio"/>	<input type="radio"/>	<input type="radio"/>	<input type="radio"/>
25"	<input type="radio"/>	<input type="radio"/>	<input type="radio"/>	<input type="radio"/>	<input type="radio"/>	<input type="radio"/>	<input type="radio"/>	<input type="radio"/>	<input type="radio"/>	<input type="radio"/>	<input type="radio"/>	<input type="radio"/>	<input type="radio"/>	<input type="radio"/>	
*With std seat upholstery decreasing rear seat height not possible in 37cm (24" wheel) and 38cm (25" wheel).															
*With std seat upholstery increasing rear seat height not possible in 49cm (24" wheel) and 50cm (25" wheel).															
													£		
SEAT UPHOLSTERY															
Seat sling standard															
HUM020002	<input type="radio"/>	With 1 utility bag											(1)		
HUM020003	<input type="checkbox"/>	With 2 utility bags											(1)	(only from SW 36cm) 43	
HUM020004	<input type="checkbox"/>	With 1 utility bag and 1 catheter bag											(1)	(only from SW 36cm) 68	
HUM020010	<input type="checkbox"/>	Seat Sling Clip Style - Airflow (user weight limit 100kg)											(1)	162	
HUM020005	<input type="checkbox"/>	With 1 utility bag											(1)	201	
HUM020006	<input type="checkbox"/>	With 2 utility bags											(1)	(only from SW 36cm Max 100Kg) 227	
HUM020007	<input type="checkbox"/>	With 1 utility bag and 1 catheter bag											(1)	(only from SW 36cm Max 100Kg) 254	
HUM020000	<input type="radio"/>	Without seat sling													
Jay Cushions - for complete product range see Jay order forms															
JAY020002	<input type="checkbox"/>	JAY Basic												50	
JAY020003	<input type="checkbox"/>	JAY Soft Combi P												70	
JAY020001	<input type="checkbox"/>	JAY Easy Visco, Curved Base												120	
JAY020007	<input type="checkbox"/>	JAY Easy Fluid, Curved Base												280	
JAY020004	<input type="checkbox"/>	JAY Lite												195	
Seat cushion black cover composite foam															
a) Foam composite		Thickness:		HUM020101		<input type="checkbox"/> 3cm		HUM020102		<input type="checkbox"/> 5cm		(medium)		55	
b) Latex		Thickness:		HUM020103		<input type="checkbox"/> 5cm		HUM020104		<input type="checkbox"/> 8cm		(very soft)		55	
Seat cushion with water resistant / breathable cover															
a) Foam composite		Thickness:		HUM020105		<input type="checkbox"/> 3cm		HUM020106		<input type="checkbox"/> 5cm		(medium)		104	
b) Latex		Thickness:		HUM020107		<input type="checkbox"/> 5cm		HUM020108		<input type="checkbox"/> 8cm		(very soft)		104	
Seat accessories															
HUM090018	<input type="checkbox"/>	Positioning belt with lock												35	
HUM020150	<input type="checkbox"/>	Spare cushion cover with zipper												37	
BACKREST															
HUM030001	<input type="radio"/>	Standard backrest		25 - 30		30 - 35		35 - 40		40 - 45					
Back height factory setting at (cm)				<input type="radio"/> 25		<input type="radio"/> 30		<input type="radio"/> 35		<input type="radio"/> 40					
				<input type="radio"/> 27.5		<input type="radio"/> 33		<input type="radio"/> 37.5		<input type="radio"/> 42.5					
				<input type="radio"/> 30		<input type="radio"/> 35		<input type="radio"/> 40		<input type="radio"/> 45					
HUM030003	<input type="checkbox"/>	Oval shaped backrest (Non Height adjustable and please pick bar setting below)													
		<input type="checkbox"/> 25	<input type="checkbox"/> 27.5	<input type="checkbox"/> 30	<input type="checkbox"/> 32.5	<input type="checkbox"/> 35	<input type="checkbox"/> 37.5	<input type="checkbox"/> 40	<input type="checkbox"/> 42.5	<input type="checkbox"/> 45				195	
HUM030403	<input type="radio"/>	Stabilizer bar setting close (9.2cm)				HUM030404				Stabilizer bar setting wide (12.4cm)				(distance away from the backrest)	
HUM030015	<input type="radio"/>	Back angle adjustable foldable											(-31° to +15°; only in black anodizing)		
HUM030012	<input type="radio"/>	Angle adjustable back (non folding)											(-31° to +15°; only in black anodizing)		
HUM030102	<input type="checkbox"/>	Double locking (angle adjustable and folding, locks in folded position)											(-31° to +15° anodised colour options on last page)		
HUM030103	<input type="checkbox"/>	Backrest width ONE size smaller than standard (-2cm less than the seat width)											(not available with Freestyle backrest)		
PUSH HANDLES															
HUM030200	<input type="radio"/>	Omit push handles													
HUM030201	<input type="radio"/>	Long											(2)		
HUM030203	<input type="checkbox"/>	Fold-down push handles											(2) (only available from 32.5cm standard back)		
HUM030211	<input type="checkbox"/>	Removable push handles											(only with Freestyle back)		
HUM030204	<input type="checkbox"/>	Height adjustable push handles											(not possible with OSB (4067) & from 32.5cm on the std backrest)		
HUM030205	<input type="checkbox"/>	Height adjustable push handles for Jay backs													
(1): no change from standard to clipstyle seat sling possible (and other way round) in the field afterwards															
(1): not available with height adjustable push handles															

		£
BACK UPHOLSTERY		
HUM030316	<input type="radio"/> EXO backrest sling, synthetic fibre, padded, adjustable, 1 accessory bag black	
Colour binding tape: <input type="radio"/> Black <input type="radio"/> Orange <input type="radio"/> Silver <input type="radio"/> Red <input type="radio"/> Blue		
HUM030317	<input type="checkbox"/> EXO PRO backrest sling, synthetic fibre, padded, adjustable, breathable, spacer fabric, 1 accessory bag, black	
Colour binding tape: <input type="checkbox"/> Black <input type="checkbox"/> Orange <input type="checkbox"/> Silver <input type="checkbox"/> Red <input type="checkbox"/> Blue		124
HUM030300	<input type="radio"/> Without backrest upholstery	
FREESTYLE BACK, ANGLE ADJUSTABLE, FOLDABLE (not crash tested)		
HUM030089	<input type="checkbox"/> Freestyle back, J3 Aluminium backrest shell, shallow contour (SC) <i>(in frame colour)</i>	500
<input type="radio"/> Backrest shell height 31cm <i>(backheight 325 - 425 mm)</i> <input type="radio"/> Backrest shell width 32cm - can be used from SW 32cm <input type="radio"/> Backrest shell width 37cm - can be used from SW 38cm		
HUM030090	<input type="checkbox"/> Freestyle back, J3 Carbon backrest shell, shallow contour (SC) <i>(backheight 275 - 350 mm)</i>	600
<input type="radio"/> Backrest shell height 24cm <input type="radio"/> Backrest shell width 32cm - can be used from SW 32cm <input type="radio"/> Backrest shell width 37cm - can be used from SW 38cm <input type="radio"/> Backrest shell width 42cm - can be used from SW 44cm <input type="radio"/> Backrest shell height 31cm <i>(backheight 325 - 425 mm)</i> <input type="radio"/> Backrest shell width 32cm - can be used from SW 32cm <input type="radio"/> Backrest shell width 37cm - can be used from SW 38cm <input type="radio"/> Backrest shell width 42cm - can be used from SW 44cm		
JAY BACKRESTS		
Shallow Contour		
JAY3 Back - Shallow Contour		
Mid Thoracic:	<input type="checkbox"/> Medium - 34 cm (JAY030010) <input type="checkbox"/> Tall - 38 cm (JAY030033)	460
Upper Thoracic:	<input type="checkbox"/> Short - 42 cm (JAY030012) <input type="checkbox"/> Medium - 46 cm (JAY030019) <input type="checkbox"/> Tall - 50 cm (JAY030025)	520
JAY3 Back - Mid Contour		
Mid Thoracic:	<input type="checkbox"/> Medium - 34 cm (JAY030011) <input type="checkbox"/> Tall - 38 cm (JAY030018)	460
Upper Thoracic:	<input type="checkbox"/> Short - 42 cm (JAY030013) <input type="checkbox"/> Medium - 46 cm (JAY030020) <input type="checkbox"/> Tall - 50 cm (JAY030026)	520
JAY3 Carbon - Shallow Contour		
Low Thoracic:	<input type="checkbox"/> Short - 17cm (JAY060001) <input type="checkbox"/> Tall - 24 cm (JAY060002)	550
Mid Thoracic:	<input type="checkbox"/> Short - 30cm (JAY060003) <input type="checkbox"/> Tall - 32 cm (JAY060004)	550
JAY3 Accessory bag		
JAY090058	<input type="checkbox"/> J3 Accessory Bag	45
JAY Accessories		
JAY030004	<input type="checkbox"/> Jay Flip Back Headrest (J3EUHDFH & J3EUHDLSP) <i>(only with J3 backs)</i>	232
JAY030006	<input type="checkbox"/> Jay Std. Headrest (J3EUHDXH & J3EUHDLSP) <i>(only with J3 backs)</i>	125
SIDE GUARDS & ARMRESTS		
HUM040101	<input type="checkbox"/> Slim style carbon side guard <i>(1)</i> <i>(slim style, carbon fibre)</i>	170
HUM040102	<input type="checkbox"/> Straight side guard aluminium (without fender)	148
HUM040103	<input type="checkbox"/> Fender side guard - aluminium <i>(min seat height 39cm)</i>	204
HUM040104	<input type="checkbox"/> Fender side guard - carbon <i>(min seat height 39cm)</i>	266
HUM040107	<input type="checkbox"/> Plastic detachable side guard <i>(Quickie style)</i>	138
HUM040108	<input type="checkbox"/> Tubular armrest, Aluminium, swing away (sideways), padded, removable (4) <i>(not in combination with handbike axle)</i>	171
Single post armrest with: <i>(Quickie style; not with tubular armrest)</i>		
HUM040050	<input type="checkbox"/> short armpad (25cm) HUM040051 <input type="checkbox"/> long armpad (33cm)	148
HUM040052	<input type="checkbox"/> Single post, tool height adjustable armrest, depth adjustable (33cm) (2) <i>(not with tubular armrest)</i>	170
HUM040000	<input type="radio"/> Without side guard	
LEGREST & FOOTPLATES		
HUM050029	<input type="radio"/> Lightweight tubular footrest <i>(lower leg length 36cm - 52cm)</i>	
HUM050030	<input type="checkbox"/> Tubular footrest lightweight with flat cover <i>(lower leg length 36cm - 52cm)</i>	62
HUM050025	<input type="checkbox"/> Platform footplate lightweight angle & depth adjustable composite <i>(lower leg length 36cm - 52cm)</i>	125
HUM050024	<input type="checkbox"/> Platform footplate lightweight angle & depth adjustable aluminium <i>(lower leg length 36cm - 52cm)</i>	125
HUM050026	<input type="checkbox"/> Platform footplate lightweight angle & depth adjustable carbon	256
HUM050034	<input type="checkbox"/> Platform footplate lightweight angle & depth adjustable aluminium, high mounted <i>(LLL 22 - 39cm)</i>	125
HUM050125	<input type="checkbox"/> Performance footplate angle adjustable <i>(lower leg length between 36cm - 52cm)</i>	187
HUM050127	<input type="checkbox"/> Foot positioning plate <i>(only with platform footplates lightweight angle & depth adjustable)</i>	17
HUM050128	<input type="checkbox"/> Footboard, platform, plastic, angle and depth adjustable, flip-up (to the back) (5) <i>(LLL from 33 cm; not with 6" castors)</i>	124
HUM050022	<input type="checkbox"/> Footboard, divided, aluminium, angle-adjust., flip-up (sideways), frame colour (3)	124
LOWER LEG LENGTH (cm) <small>Attention: LLL has to be 3cm less than front seat height. All measurements are in cm</small>		
<input type="radio"/> 22 <input type="radio"/> 23 <input type="radio"/> 24 <input type="radio"/> 25 <input type="radio"/> 26 <input type="radio"/> 27 <input type="radio"/> 28 <input type="radio"/> 29 <input type="radio"/> 30 <input type="radio"/> 31 <input type="radio"/> 32 <input type="radio"/> 33 <input type="radio"/> 34 <input type="radio"/> 35 <input type="radio"/> 36 <input type="radio"/> 37 <input type="radio"/> 38 <input type="radio"/> 39 <input type="radio"/> 40 <input type="radio"/> 41 <input type="radio"/> 42 <input type="radio"/> 43 <input type="radio"/> 44 <input type="radio"/> 45 <input type="radio"/> 46 <input type="radio"/> 47 <input type="radio"/> 48 <input type="radio"/> 50 <input type="radio"/> 51 <input type="radio"/> 52		
Low Frame: LLL 22-35cm only with high mounted footrest; for all other footrests from LLL 36-50cm		
High Frame: LLL 22-39cm only with high mounted footrest; for all other footrests from LLL 39-52cm		
(1):	with 24" rear wheel minimum rear seat height 41cm; with 25" rear wheel minimum rear seat height 43cm	
(2):	not with centre of gravity 9.2 & 10.4cm in combination with lightweight seat upholstery	
(3):	Lower leg length from 38cm with low frame, from 42cm with high frame, not with 4" and 6" castor	
(4):	only with slim style sideguard, Aluminium sideguard w/o fender or w/o sideguard. Not with lightweight upholstery.	
(5):	user weight limitation 75kg, lower leg length from 33cm, not with 4" castor	
(6):	not with height adjustable push handles	

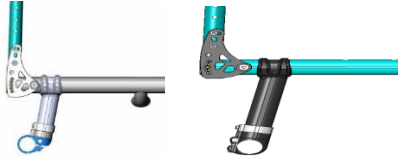
			£	
FRAME VERSIONS (first choose frame length, then frame angle and inset)				
HUM010206	<input type="radio"/>	Standard frame		
HUM010207	<input type="radio"/>	Long frame <i>(not in combination with SD 46cm; recommended with narrow castor house position)</i>		
HUM010012	<input type="radio"/>	100° Fixed front frame (UK 80°) (1)		
HUM010013	<input type="checkbox"/>	92° Performance fixed front frame (UK 88°) (1)	97	
HUM010009	<input type="checkbox"/>	88° Performance compact fixed front frame (UK 92°) <i>(not available with 1cm inset option)</i>	97	
HUM010100	<input type="radio"/>	Inset: Standard (0cm)		
HUM010101	<input type="radio"/>	Inset: Small (1cm) <i>(not in combination with 88° frame)</i>		
HUM010103	<input type="checkbox"/>	Inset: (3cm) only for frame angle 88° & 92° <i>(not available for seat width 32 cm)</i>	97	
HUM010301	<input type="radio"/>	Castor house position wide		
HUM010302	<input type="radio"/>	Castor house position narrow <i>(only for inset 3cm, not available with 88° performance compact frame)</i>		
HUM010500	<input type="checkbox"/>	Handbike axle (2) <i>(always 3° more than the std axle camber)</i>	266	
CENTRE OF GRAVITY (COG)				
Choose only one of the 8 choices		(measured from front of back post in cm)		
COG20	<input type="radio"/>	2.00cm		
COG32	<input type="radio"/>	3.20cm		
COG44	<input type="radio"/>	4.40cm		
COG56	<input type="radio"/>	5.60cm		
COG68	<input type="radio"/>	6.80cm		
COG80	<input type="radio"/>	8.00cm		
COG92	<input type="radio"/>	9.20cm		
COG104	<input type="radio"/>	10.40cm		
FRAME ACCESSORIES				
HUM090031	<input type="checkbox"/>	Suspension up to 70kg (3)	380	
HUM090032	<input type="checkbox"/>	Suspension up to 120kg (3)	380	
Tip assist (step tube)				
HUM090001	<input type="checkbox"/>	Left <i>HUM090002</i> <input type="checkbox"/>	Right	24
HUM090003	<input type="checkbox"/>	Pair	<i>(not available with ant-tip)</i>	45
HUM090009	<input type="checkbox"/>	Crutch holder	<i>(only in combination with tip assist)</i>	56
Anti-tip tubes swing-away				
HUM090004	<input type="checkbox"/>	Left <i>HUM090005</i> <input type="checkbox"/>	Right	74
HUM090006	<input type="checkbox"/>	Pair	<i>(not available with tip-assist)</i>	148
HUM090007	<input type="checkbox"/>	Quickie style anti-tip tubes pluggable	<i>(Pair)</i>	62
Anti-tip flip-up (user operated) <i>(not in combination with handbike axle)</i>				
HUM090033	<input type="checkbox"/>	Left		113
HUM090008	<input type="checkbox"/>	Right		113
HUM090035	<input type="checkbox"/>	Sport anti-tip, central mount, pluggable	<i>(For use with indoor not contact sports only; e.g. badminton/dancing)</i>	227
HUM090010	<input type="checkbox"/>	Transit wheels (3" wheels)		164
HUM090016	<input type="checkbox"/>	Frame protection		56
PREPARATION FOR ATTITUDE ADD-ON BIKE				
HUM090211	<input type="checkbox"/>	Preparation for ATTITUDE, without ATTITUDE order	<i>(docking pins assembled)</i>	82
HUM090212	<input type="radio"/>	Preparation for ATTITUDE, with ATTITUDE order	<i>(docking pins assembled; ATTITUDE order separately)</i>	
FORKS				
HUM080013	<input type="radio"/>	Carbotecture fork	<i>(colours: see colour options on page 6)</i>	
HUM080008	<input type="checkbox"/>	Single arm fork <i>(only 111mm length & only with 4" & 5" Alu soft, Alu solid.)</i>	<i>(colours: see colour options on page 6)</i>	142
HUM080029	<input type="radio"/>	Aluminium fork	<i>(colours: see colour options on page 6. Only available in black, orange and silver)</i>	
HUM080007	<input type="checkbox"/>	Frog Leg fork	<i>(only in combination with 4" & 5" solid & all ALU casters; only black)</i>	238
HUM090093	<input type="checkbox"/>	Fork for power add ons, 123mm (Aluminium)	<i>(only in black.)</i>	56
CASTOR				
HUM080301	<input type="radio"/>	Solid	<i>(3"-6", not with One arm fork)</i>	
HUM080302	<input type="radio"/>	Soft	<i>(only 5" and 6", not with One arm fork, for 45 mm fork version only)</i>	
HUM080303	<input type="checkbox"/>	Solid light up	<i>(not available for 6", not with One arm fork)</i>	56
HUM080304	<input type="checkbox"/>	Solid with aluminium rim, colour rim: silver only	<i>(only for 4" and 5", use with one arm fork)</i>	66
HUM080306	<input type="checkbox"/>	Soft with aluminium rim <i>(for 45mm fork version only)</i>	<i>(only for 4" and 5", use with one arm fork, pick colours on last page)</i>	66
(1): no change from 3" & 4" castor to 5" & 6" is possible afterwards				
(2): Max user weight 100kg. Only with 3°, 6° & 9° camber; not in combination with carbon sideguards, lightweight seat upholstery and not in combination with lightweight compact wheel lock				
(3): not with COG 6.8 - 10.4cm. Not with rear seat height 37 - 42cm and 24" wheels. Not with rear seat height 37 - 43cm and 25" wheels with standard seat upholstery				

						£
REAR WHEELS						
<i>NOTE: for users with higher user weight than 100kg, we recommend cross spoked wheels</i>						
HUM070001	<input type="radio"/>	Universal Cross spoked	(pair)		(only 24")	
HUM070002	<input type="radio"/>	Design wheel	(pair)		(only 24")	
HUM070003	<input type="radio"/>	Lightweight wheel	(pair)	(Colour anodizing selection for 24" LW wheel on the last page)		
HUM070004	<input type="checkbox"/>	Proton wheel (super lightweight)	(pair)		(user weight limit 100kg)	406
HUM070005	<input type="checkbox"/>	Spinergy wheels 18 spokes, colour hub: silver	(1) (pair)	(black spokes; other colours available via B4M)		368
HUM070006	<input type="checkbox"/>	Spinergy wheels 12 spokes, colour hub: silver	(1) (pair)	(black spokes; other colours available via B4M)		567
HUM070007	<input type="checkbox"/>	Spinergy wheels 12 spokes, colour hub: black	(pair)	(black spokes; other colours available via B4M)		567
HUM070009	<input type="checkbox"/>	Mountain bike wheel		(only with 24", mountain bike tyres & aluminium rim, black coated)		250
HUM070010	<input type="checkbox"/>	Additional mountain bike wheel (pair)		(only with 24" & mountain bike tyres)		250
HUM070000	<input type="radio"/>	Omit rear wheels				
TYRES (choose only one tyre type)						
HUM070101	<input type="radio"/>	Right Run			(only 24")	
HUM070102	<input type="radio"/>	Solid tyres			(only 24")	
HUM070106	<input type="checkbox"/>	Down Town Two Grip			(only 24")	75
HUM070107	<input type="checkbox"/>	Schwalbe One (slight puncture protection)				75
HUM070104	<input type="checkbox"/>	Marathon plus evolution (puncture resistant)				75
HANDRIM						
HUM070201	<input type="radio"/>	Aluminium silver powder coated				
HUM070202	<input type="radio"/>	Aluminium silver anodised				
HUM070204	<input type="radio"/>	Stainless steel				
HUM070203	<input type="checkbox"/>	Aluminium colour powder coated		(pick colour for handrim in colour list charged at £52.00)		
HUM070205	<input type="checkbox"/>	Titanium		(25" only in combination with Spinergy)		155
HUM070206	<input type="checkbox"/>	Titanium clear powder coated		(pick colour for handrim in colour list; 25" only in combination with Spinergy)		155
HUM070207	<input type="checkbox"/>	Supergrip		(only 24" wheels)		187
HUM070208	<input type="checkbox"/>	Max Grepp		(only 24" wheels)		187
HUM070211	<input type="checkbox"/>	Surge [®] LT				149
Handrim mounting		HUM070317	<input type="radio"/>	Close 12 - 17mm		
		HUM070327	<input type="radio"/>	Wide 27mm	(Not with light weight, Proton & Spinergy wheel and alu handrim)	
		HUM070307	<input type="radio"/>	Extra close 7mm	(only with stainl. steel or Surge, only with 24" Design & Univ. wheel)	
HUM070250	<input type="checkbox"/>	Handrim cover			(only 24" wheels)	75
AXLE TUBE						
HUM010401	<input type="radio"/>	Standard axle tube				
HUM010402	<input type="checkbox"/>	Carbon axle tube			(only for 0° and 3° wheel chamber)	171
CAMBER (choose only one option)						
HUM070600	<input type="radio"/>	0°				
HUM070603	<input type="radio"/>	3°				
HUM070606	<input type="radio"/>	6°			(not available with carbon axle tube)	
HUM070609	<input type="radio"/>	9°			(not available with carbon axle tube)	
SPOKE GUARDS						
HUM070831	<input type="checkbox"/>	Transparent			(only available in 22", 24" & 26")	103
	<input type="checkbox"/>	Spoke guards	Number	Description		103
<p>Please consult the last page of this order form to choose your selection, or to order a copy of our new brochure please call 0845 605 66 88 or e-mail literaturerequests@sunmed.co.uk. You can also view the brochure online by visiting www.sunrisemedical.co.uk and navigating to Quickie Helium. You will find the brochure under "documentation"</p>						
WHEEL LOCKS (choose only one option)						
HUM060001	<input type="radio"/>	Standard wheel lock				
HUM060003	<input type="radio"/>	Compact wheel lock	(2)			
HUM060004	<input type="checkbox"/>	Lightweight compact	(2) (3) (4)			121
HUM060002	<input type="checkbox"/>	Knee lever wheel lock				47
HUM060010	<input type="checkbox"/>	Extension for knee lever wheel lock, slip-on, swing-away			(only on HUM060002)	32
HUM060006	<input type="checkbox"/>	One arm wheel lock left				127
HUM060007	<input type="checkbox"/>	One arm wheel lock right				127
(1): only with handrim Aluminium silver powdercoated						
(2) Not available with 6° & 9° camber (please check NoGo-Matrix)						
(3) Adjustment of COG ± 2 cm on a chair in the field.						
(4) Not for use with add-on bikes						

								£					
ACCESSORIES													
HUM090000	<input type="radio"/>	Tool kit											
HUM090100	<input type="radio"/>	Transportation brackets - Crash test option				<i>(not available on Helium Pro)</i>							
HUM090017	<input type="checkbox"/>	Snoll on (1)				<i>(Max user weight: 100kg)</i>		454					
HUM090024	<input type="checkbox"/>	High pressure pump						62					
HUM090025	<input type="checkbox"/>	Air pump						13					
HUM090030	<input type="checkbox"/>	Back pack						50					
HUM090020	<input type="checkbox"/>	Net back bag						18					
HUM090019	<input type="checkbox"/>	Caddy				<i>(not with platform footplates)</i>		50					
HUM090026	<input type="checkbox"/>	Mobile phone pouch						37					
HUM090014	<input type="checkbox"/>	Handbike re-enforcement tubes				<i>(Only with handbike axle)</i>		290					
COLOURS													
<i>Please visit www.quickiewheelchairs.eu/xenonsa to choose your colours</i>													
	Frame	Handrim	Hub/Rim (2)		Frame	Handrim	Hub/Rim (2)						
		£51	£144			£51	£144						
01 White RAL 9010	<input type="radio"/>	<input type="checkbox"/>	<input type="checkbox"/>		26 Silver Texture	<input type="radio"/>	<input type="checkbox"/>						
02 Brilliant Silver	<input type="radio"/>	<input type="checkbox"/>	<input type="checkbox"/>		27 Graphite metallic	<input type="radio"/>	<input type="checkbox"/>						
03 Silver Matt	<input type="radio"/>	<input type="checkbox"/>	<input type="checkbox"/>		28 Platinum metallic	<input type="radio"/>	<input type="checkbox"/>						
04 Silver	<input type="radio"/>	<input type="checkbox"/>	<input type="checkbox"/>		29 Black	<input type="radio"/>	<input type="checkbox"/>						
06 Sun Yellow	<input type="radio"/>	<input type="checkbox"/>	<input type="checkbox"/>		31 Matt Black	<input type="radio"/>	<input type="checkbox"/>						
07 Brilliant Lime	<input type="radio"/>	<input type="checkbox"/>	<input type="checkbox"/>		32 Signal White	<input type="radio"/>	<input type="checkbox"/>						
08 Matt Lime	<input type="radio"/>	<input type="checkbox"/>	<input type="checkbox"/>		33 Pink	<input type="radio"/>	<input type="checkbox"/>						
14 Blue	<input type="radio"/>	<input type="checkbox"/>	<input type="checkbox"/>		34 Dark Chocolate Metallic	<input type="radio"/>	<input type="checkbox"/>						
15 Brilliant Marine	<input type="radio"/>	<input type="checkbox"/>	<input type="checkbox"/>		35 Skyblue	<input type="radio"/>	<input type="checkbox"/>						
16 Matt Marine	<input type="radio"/>	<input type="checkbox"/>	<input type="checkbox"/>		36 Cyan-Metallic	<input type="radio"/>	<input type="checkbox"/>						
19 Brilliant Purple	<input type="radio"/>	<input type="checkbox"/>	<input type="checkbox"/>		37 Mars Red (Orange)	<input type="radio"/>	<input type="checkbox"/>						
20 Matt Purple	<input type="radio"/>	<input type="checkbox"/>	<input type="checkbox"/>		39 Cappuccino	<input type="radio"/>	<input type="checkbox"/>						
21 Red Ruby	<input type="radio"/>	<input type="checkbox"/>	<input type="checkbox"/>		40 Kiwi	<input type="radio"/>	<input type="checkbox"/>						
22 Brilliant Red	<input type="radio"/>	<input type="checkbox"/>	<input type="checkbox"/>		41 Flamingo-Glitter	<input type="radio"/>	<input type="checkbox"/>						
23 Matt Red	<input type="radio"/>	<input type="checkbox"/>	<input type="checkbox"/>		42 Matt-Anthracite	<input type="radio"/>	<input type="checkbox"/>						
24 Tutti Frutti Orange	<input type="radio"/>	<input type="checkbox"/>	<input type="checkbox"/>		43 Azure Blue	<input type="radio"/>	<input type="checkbox"/>						
24" LIGHTWEIGHT WHEELS													
HUM100336	<input type="radio"/>	Orange anodised (3)		HUM100337	<input type="radio"/>	Blue anodised (3)							
HUM100338	<input type="radio"/>	Red anodised (3)											
BACKREST BRACKET (Double locking back only)													
HUM030035	<input type="radio"/>	Black		HUM030037	<input type="radio"/>	Silver		HUM030039	<input type="radio"/>	Blue (6)			
HUM030036	<input type="radio"/>	Orange		HUM030038	<input type="radio"/>	Red (6)							
CASTOR FORKS													
HUM080041	<input type="radio"/>	Black		HUM080042	<input type="radio"/>	Silver		HUM080045	<input type="radio"/>	Blue			
HUM080043	<input type="radio"/>	Orange		HUM080044	<input type="radio"/>	Red							
CASTOR WHEEL (Only soft with aluminium rim)													
HUM080311	<input type="radio"/>	Black		HUM080313	<input type="radio"/>	Orange		HUM080315	<input type="radio"/>	Blue			
HUM080312	<input type="radio"/>	Silver		HUM080314	<input type="radio"/>	Red							
STICKERS													
HUM100550	<input type="radio"/>	Black		HUM100552	<input type="radio"/>	Orange		HUM100554	<input type="radio"/>	Blue			
HUM100551	<input type="radio"/>	Silver		HUM100553	<input type="radio"/>	Red							
AXLE STEM SPACER (Not available on Helium Pro)													
HUM100560	<input type="radio"/>	Silver		HUM100562	<input type="radio"/>	Red							
HUM100561	<input type="radio"/>	Orange		HUM100563	<input type="radio"/>	Blue							
FRAME TRANSFERS (Dots)													
HUM100570	<input type="radio"/>	Black		HUM100571	<input type="radio"/>	Silver		HUM100574	<input type="radio"/>	Blue			
HUM100572	<input type="radio"/>	Orange		HUM100573	<input type="radio"/>	Red		HUM100575	<input type="radio"/>	Matt Black			
<p>(1) Not in combination with performance footrest and high mounted footrest</p> <p>(2) Only with universal cross spoke rear wheel</p> <p>(3) Anodised colours for hub and rim, black spokes. Only with light weight wheel in 24"</p> <p>(4) Froglegs fork and fork for power add-ons (HUM090093) only available in black. Backrest bracket only in combination with HUM030102 "double locking back" in colours, otherwise always black.</p> <p>(5) Only with 111mm forks (including one-arm fork) in combination with HUM080302 Castor, soft or HUM080306 Castor soft with aluminium rim</p> <p>(6) Only with carbotechnology forks</p>													
Option price													
Total Price													

Please follow this measuring method:

The following method is recommended on the basis of extensive practical experience. Deviations are possible in individual instances.

Seat width (SW):

- a) *For the user:* Allow space between sideguard and hip on each side of the chair (approx. 1 - 2cm altogether)
- b) *On the wheelchair:* From outside frame tube to outside frame tube.

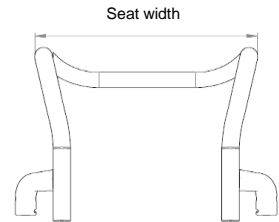

Seat depth (SD):

- a) *For the user:* When sitting upright: leave space for 2 - 3 fingers between front edge of the seat upholstery and back of knee (approx. 3 - 6 cm). Care must be taken with adj. upholstery.
- b) *On the wheelchair:* From back tube to front of seat upholstery.

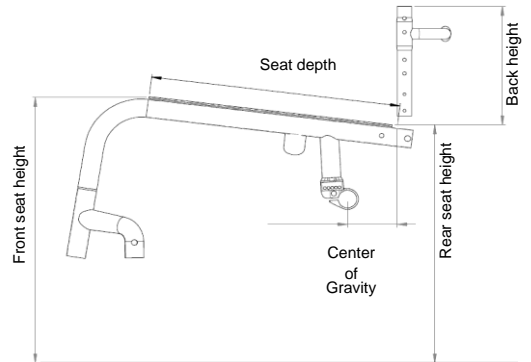

Front seat height:

- a) *For the user:* When sitting with 90° kneeangle: From back of knee to bottom of shoe sole.
- b) *On the wheelchair:* From front of seat tube to the ground . (min. 3cm longer than user measurement) Remember to include the cushion height.

Rear seat height:

- b) *On the wheelchair:* From back of seat tube to the ground. **Note:** Max. seat height difference rear to front is 13 cm

Back height:

- a) *For the user:* From the seat, including cushion, to be no more than 1 - 2 cm below the lower shoulder blade.
- b) *On the wheelchair:* From back of seat tube to upper edge of backrest upholstery. **Note:** The user's ability to sit upright has a major influence on the back height and it can therefore differ considerably

Back angle:

Important: The back height depends on the degree of disability. 0° is the angle 90° to the seat. Negative angles are <90° and positive angles are >90°.

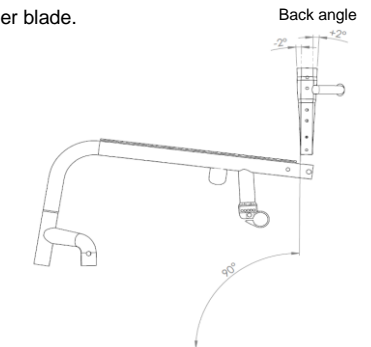

Low Seat Frame vs. High Seat Frame:

The high frame is 4 cm higher than the low frame. So you can choose shorter and lighter forks to minimize the weight of your wheelchair.

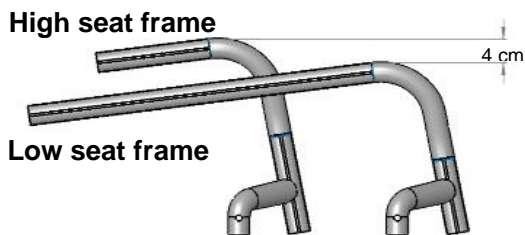

Technical Data Overview:

Overall width:	Overall width with:	24" rear wheel	25" rear wheel
Overall width:	For 0° camber:	SW + 17 cm	SW + 17 cm
Max overall height	For 3° camber:	SW + 23 cm	SW + 24 cm
Max overall length	For 6° camber:	SW + 29 cm	SW + 30 cm

Please note that the matrix is based on a std configuration:
Std chair 40 x 40 cm; 3° camber; 5,60 cm CoG; Seat angle of 8°
 All changes in the configuration might change the seat heights.
 Manufacturing tolerances of +/- 1 cm

Supporting Pictures

Seating

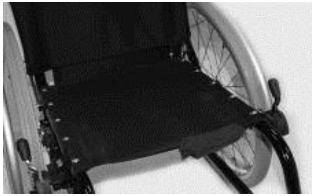

HUM020002
Seat sling with 1 utility bag

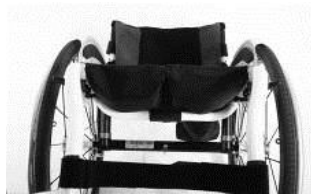

HUM020004
Seat sling with 1 utility bag and 1 catheter bag



HUM020010
Seat sling clip style (air flow) without utility bag



HUM090018
Positioning belt with lock

Backrest

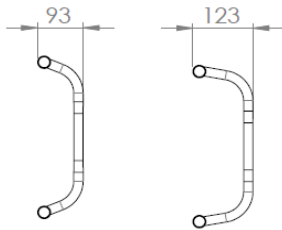

HUM030403 & HUM030404
Stabilizer bar close & wide



HUM030015
Back angle adjustable foldable



HUM030203
Integral pushhandles long



HUM030203
Fold-down push handles



HUM030204
Height adj. Push handles



HUM030316
EXO Pro Backrest upholstery



HUM030317
EXO Backrest upholstery

Supporting Pictures

Backrests

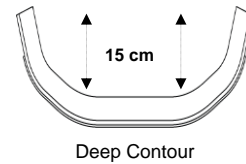
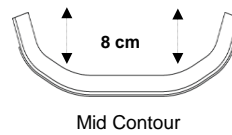
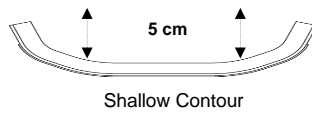

Side Guards



HUM040101
Slim style carbon side guard



HUM040102
Aluminium side guard without fender



HUM040103
Aluminium side guard with fender



HUM040104
Carbon side guard with fender



HUM040107
Plastic detachable side guard

Legrests and Footplates



HUM050029
Tubular footrest
lightweight



HUM050030
Tubular footrest lightweight
with flat cover



HUM050034
Platform footplate lightweight
angle & depth adjustable
aluminium, high mounted



HUM050125
Performance footplate angle
adjustable



HUM050127
Foot positioning plate

Frame Standard vs. Frame Long

Difference is 2cm

HUM010206
Standard frame

HUM010207
Long frame

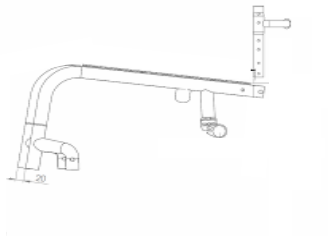

Frame Angles:



HUM010012

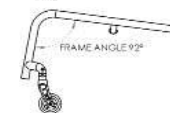

HUM010013

Frame inset table (Graphs below are showing an example for SW 34)

Inset		Seat Width (cm)							
		32	34	36	38	40	42	44	46
0cm	Frame width inside	27	29	31	33	35	37	39	41
	Frame width castor house	44	46	48	50	52	54	56	58
1cm	Frame width inside	25	27	29	31	33	35	37	39
	Frame width castor house	42	44	46	48	50	52	54	56
3cm	Frame width inside	NA	23	25	27	29	31	33	35
	Frame width castor house wide	NA	46	48	50	52	54	56	58
	Frame width castor house small	NA	40	42	44	46	48	50	52

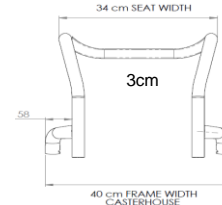
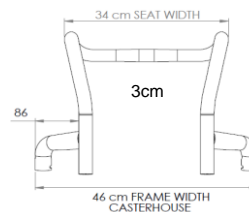
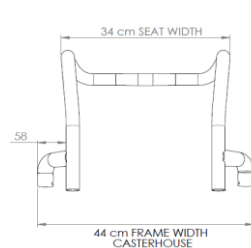
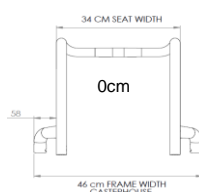

Supporting Pictures

Frame Accessories



HUM090032
Suspension



HUM090001
Tip assist - left
HUM090002
Tip assist - right
HUM090003
Tip assist - pair



HUM090004
Anti-tip tubes SA - left
HUM090005
Anti-tip tubes SA - right
HUM090006
Anti-tip tubes SA - pair



HUM090007
Quickie style anti-tip tubes pluggable



HUM090033
Anti-tip flip-up (user operated) - left
HUM090008
Anti-tip flip-up (user operated) - right



HUM090035
Sport anti-tip, central mount, pluggable



HUM090010
Transit Wheels



HUM090016
Frame Protection

Rear Wheels



HUM070001
Universal Cross spoked



HUM070002
Design Wheel



HUM070003
Lightweight wheel



HUM070004
Proton Wheel
(super lightweight)



HUM070005
Spinergy Wheel - 18 spokes
HUM070006
Spinergy Wheel - 12 spokes

Tyres



HUM070101
Right Run



HUM070106
Down town two grip



HUM070107
Schwalbe One



HUM070102
Solid Tyres



HUM070104
Marathon plus evolution
(puncture resistant)



HUM100501-05
Coloured forks as part of the style package in combination with
HUM060305 Castor soft with aluminium rim, coloured



HUM070003
Rear wheel lightweight, 24", colour choice on the last page

NoGo Matrix for Lightweight Compact Brake

Seat height values are valid with 56mm COG, seat depth 400mm and 8° seat angle, axle stem assembled with one spacer

SD 42 - 48

24"		Front Seat Height														25"		Front Seat Height															
Cog/ SH		43	44	45	46	47	48	49	50	51	52	53	54	55	56	57	Cog/ SH		43	44	45	46	47	48	49	50	51	52	53	54	55	56	57
2		✓	✓	✓	✓	✓	✓	✓	✓	✓	✓	✓	✓	✓	✓	✓	2		✓	✓	✓	✓	✓	✓	✓	✓	✓	✓	✓	✓	✓	✓	
3.2		✓	✓	✓	✓	✓	✓	✓	✓	✓	✓	✓	✓	✓	✓	✓	3.2		✓	✓	✓	✓	✓	✓	✓	✓	✓	✓	✓	✓	✓	✓	✓
4.4		✓	✓	✓	✓	✓	✓	✓	✓	✓	✓	✓	✓	✓	✓	✓	4.4		✓	✓	✓	✓	✓	✓	✓	✓	✓	✓	✓	✓	✓	✓	✓
5.6		✓	✓	✓	✓	✓	✓	✓	✓	✓	✓	✓	✓	✓	✓	✓	5.6		✓	✓	✓	✓	✓	✓	✓	✓	✓	✓	✓	✓	✓	✓	✓
6.8		✓	✓	✓	✓	✓	✓	✓	✓	✓	✓	✓	✓	✓	✓	✓	6.8		✓	✓	✓	✓	✓	✓	✓	✓	✓	✓	✓	✓	✓	✓	✓
8		✓	✓	✓	✓	✓	✓	✓	✓	✓	✓	✓	✓	✓	✓	✓	8		✓	✓	✓	✓	✓	✓	✓	✓	✓	✓	✓	✓	✓	✓	✓
9.2		✓	✓	✓	✓	✓	✓	✓	✓	✓	✓	✓	✓	✓	✓	✓	9.2		✓	✓	✓	✓	✓	✓	✓	✓	✓	✓	✓	✓	✓	✓	✓
10.4		✓	✓	✓	✓	✓	✓	✓	✓	✓	✓	✓	✓	✓	✓	✓	10.4		✓	✓	✓	✓	✓	✓	✓	✓	✓	✓	✓	✓	✓	✓	✓

SD 40

24"		Front Seat Height														25"		Front Seat Height															
Cog/ SH		43	44	45	46	47	48	49	50	51	52	53	54	55	56	57	Cog/ SH		43	44	45	46	47	48	49	50	51	52	53	54	55	56	57
2		✓	✓	✓	✓	✓	✓	✓	✓	✓	✓	✓	✓	✓	✓	✓	2		✓	✓	✓	✓	✓	✓	✓	✓	✓	✓	✓	✓	✓	✓	✓
3.2		✓	✓	✓	✓	✓	✓	✓	✓	✓	✓	✓	✓	✓	✓	✓	3.2		✓	✓	✓	✓	✓	✓	✓	✓	✓	✓	✓	✓	✓	✓	✓
4.4		✓	✓	✓	✓	✓	✓	✓	✓	✓	✓	✓	✓	✓	✓	✓	4.4		✓	✓	✓	✓	✓	✓	✓	✓	✓	✓	✓	✓	✓	✓	✓
5.6		✓	✓	✓	✓	✓	✓	✓	✓	✓	✓	✓	✓	✓	✓	✓	5.6		✓	✓	✓	✓	✓	✓	✓	✓	✓	✓	✓	✓	✓	✓	✓
6.8		✓	✓	✓	✓	✓	✓	✓	✓	✓	✓	✓	✓	✓	✓	✓	6.8		✓	✓	✓	✓	✓	✓	✓	✓	✓	✓	✓	✓	✓	✓	✓
8		✓	✓	✓	✓	✓	✓	✓	✓	✓	✓	✓	✓	✓	✓	✓	8		✓	✓	✓	✓	✓	✓	✓	✓	✓	✓	✓	✓	✓	✓	✓
9.2		✓	✓	✓	✓	✓	✓	✓	✓	✓	✓	✓	✓	✓	✓	✓	9.2		X	X	✓	✓	✓	✓	✓	✓	✓	✓	✓	✓	✓	✓	✓
10.4		✓	✓	✓	✓	✓	✓	✓	✓	✓	✓	✓	✓	✓	✓	✓	10.4		X	X	X	X	X	X	✓	✓	✓	✓	✓	✓	✓	✓	✓

SD 34 - 38

24"		Front Seat Height														25"		Front Seat Height															
Cog/ SH		43	44	45	46	47	48	49	50	51	52	53	54	55	56	57	Cog/ SH		43	44	45	46	47	48	49	50	51	52	53	54	55	56	57
2		✓	✓	✓	✓	✓	✓	✓	✓	✓	✓	✓	✓	✓	✓	✓	2		✓	✓	✓	✓	✓	✓	✓	✓	✓	✓	✓	✓	✓	✓	✓
3.2		✓	✓	✓	✓	✓	✓	✓	✓	✓	✓	✓	✓	✓	✓	✓	3.2		✓	✓	✓	✓	✓	✓	✓	✓	✓	✓	✓	✓	✓	✓	✓
4.4		✓	✓	✓	✓	✓	✓	✓	✓	✓	✓	✓	✓	✓	✓	✓	4.4		✓	✓	✓	✓	✓	✓	✓	✓	✓	✓	✓	✓	✓	✓	✓
5.6		✓	✓	✓	✓	✓	✓	✓	✓	✓	✓	✓	✓	✓	✓	✓	5.6		✓	✓	✓	✓	✓	✓	✓	✓	✓	✓	✓	✓	✓	✓	✓
6.8		✓	✓	✓	✓	✓	✓	✓	✓	✓	✓	✓	✓	✓	✓	✓	6.8		X	✓	✓	✓	✓	✓	✓	✓	✓	✓	✓	✓	✓	✓	✓
8		X	✓	✓	✓	✓	✓	✓	✓	✓	✓	✓	✓	✓	✓	✓	8		X	X	X	X	X	X	✓	✓	✓	✓	✓	✓	✓	✓	✓
9.2		X	X	X	✓	✓	✓	✓	✓	✓	✓	✓	✓	✓	✓	✓	9.2		X	X	X	X	X	X	X	X	✓	✓	✓	✓	✓	✓	✓
10.4		X	X	X	X	X	X	✓	✓	✓	✓	✓	✓	✓	✓	✓	10.4		X	X	X	X	X	X	X	X	X	X	X	X	✓	✓	✓

Possible

NoGo

Supporting Pictures



HUM070208
Max Grepp



HUM070211
Surge LT

Axle Tubes



HUM010401
Standard axle tube



HUM010402
Carbon axle tube

Wheel Locks



HUM060001
Standard Wheel lock



HUM060002
Knee lever wheel lock



HUM060003
Compact wheel lock



HUM060004
Lightweight compact



HUM070823 - Princess



HUM070808 - Dancing Bear



HUM070818 - Jungle Fever



HUM070816 - Happy Lions



HUM070832 - Water World



HUM070825 - Randolf



HUM070819 - Monkeys



HUM070821 - Pirates



HUM070811 - Feather



HUM070820 - Oriental



HUM070824 - Racing



HUM070809 - Dirt Race



HUM070829 - Superhero



HUM070814 - Graffiti



HUM070806 - Chrome Wheel



HUM070817 - Hot Wheels



HUM070802 - Basketball



HUM0708036 - Basketball 2



HUM070822 - Pool



HUM070812 - Flying Water



HUM070828 - Space



HUM070827 - Silk



HUM070801 - Abstract



HUM070807 - Creative



HUM070830 - Tiger



HUM070833 - Zebra

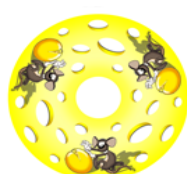

HUM070805 - Cheese



HUM070804 - Bibbo



HUM070813 - Galactica



HUM070826 - Rotation



HUM070810 - Fantasy



HUM070815 - Graphic